

Please read and save these instructions. Read carefully before attempting to assemble, install, operate or maintain the product described.
Protect yourself and others by observing all safety information. Failure to comply with instructions could result in personal injury and/or property damage! Retain instructions for future reference.

AMERICOOOL by WELTEM Portable Air Conditioners

Description

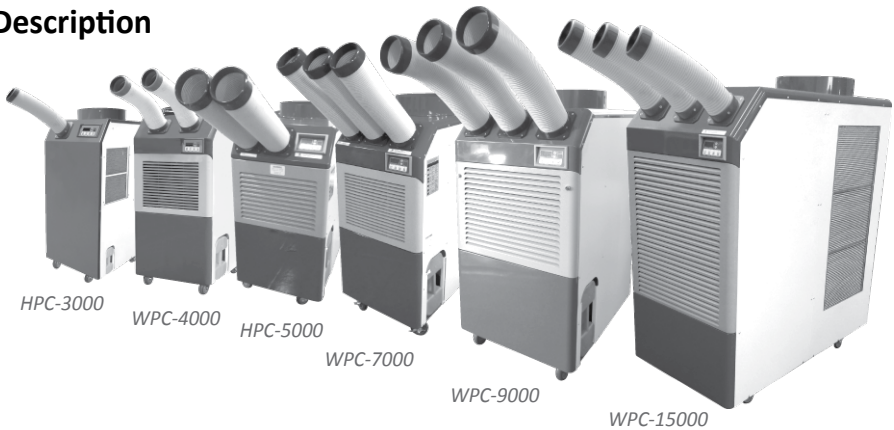

AmeriCool by Weltem Portable Air Conditioners feature spot cooling for large areas where cooling of the entire area is not practical. A dedicated spot cooling thermostat controls the unit in this application. These air conditioners can also be used in smaller areas for room cooling.

A control panel provides ease of use and contains a self-diagnostic function and display, showing operating modes, room and set temperatures, and faults. If an abnormal operation occurs, a visual display of the fault is shown. Caster wheels are included for easy portability. Suitable applications include: a factory or work place, industrial kitchen, computer room, emergency cooling, outdoor event, etc.

Unpacking

After unpacking the unit, carefully inspect unit for any damage that may have occurred during transit. Check for any loose, missing, or damaged parts.

Table of Contents

IMPORTANT SAFETY INSTRUCTIONS.....	4
INTRODUCTION.....	6
PRODUCT DESCRIPTION.....	6
ASSEMBLY(HPC-3000).....	7
Component Parts	
Power Cord Holder	
Discharge Ducts / Supply Air Duct	
Exhaust Flange(Optional)	
Ambient Air Adapters(Optional)	
ASSEMBLY(HPC-4000).....	8
Component Parts	
Power Cord Holder	
Discharge Ducts / Supply Air Duct	
Exhaust Flange(Optional)	
Ambient Air Adapters(Optional)	
ASSEMBLY(HPC-5000).....	9
Component Parts	
Power Cord Holder	
Rubber Stoppers	
Discharge Ducts / Supply Air Duct	
Exhaust Flange(Optional)	
Ambient Air Adapters(Optional)	
ASSEMBLY(WPC-7000,9000).....	10
Component Parts	
Power Cord Holder	
Top Fan Exhaust Flange	
Discharge Ducts / Supply Air Duct	
Ambient Air Adapters(Optional)	
ASSEMBLY(WPC-15000).....	11
Component Parts	
Power Cord Holder	
Discharge Ducts / Supply Air Duct	
Exhaust Flange	
Ambient Air Adapters(Optional)	

INSTALLATION GUIDE.....12
 Moving the Unit
 Plugging in the Unit

OPERATION.....14
 Control Panel

MAINTENANCE.....15
 Filter Cleaning
 Spring Replacement

TROUBLESHOOTING.....18
 Alarm Codes
 Troubleshooting Chart

SPECIFICATIONS.....21

WIRING DIAGRAM.....23

SHIPPING LIST.....26

OBTAINING SERVICE.....26

LIMITED WARRANTY.....28

Thank you for selecting this AmeriCool by Weltem Portable Air Conditioner. It provides you with spot cooling for large areas where cooling of an entire area is not practical or possible. **Please read this manual** before installing the HPC-3000, WPC-4000, HPC-5000, WPC-7000, WPC-9000 or WPC-15000 as it provides important information that should be followed during installation and maintenance of the Portable Air Conditioner, allowing you to correctly set up your system for the maximum safety and performance. Included is information on customer support and service, if it is required. If you experience a problem with the unit, please refer to the Troubleshooting section in this manual to correct the problem. If the problem is not corrected, please collect information so that the Technical Support personnel can more effectively assist you.

IMPORTANT SAFETY INSTRUCTIONS:

(SAVE THESE INSTRUCTIONS)

Please read this manual carefully for instructions on correct installation and usage. Please read all safety instructions.

1. Transport and store the unit in an upright position only. Leave the unit in an upright position for at least 3 hours before use.
2. Always place the unit on an even, level surface.
3. Ensure the unit is connected to a grounded utility of the correct rating / capacity.
4. The unit will cool when the room temperature is between 64.4°F - 113°F (18°C - 45°C) depending on the thermostat setting.
5. **DO NOT** use this unit for functions other than those described in this User's Manual.
6. **DO NOT** tilt the unit.
7. **DO NOT** cover or obstruct the unit's inlet and/or outlet grilles.
8. **DO NOT** use the unit in areas where it will be exposed to rain or water.
9. **NEVER** unplug the unit while it is operating



WARNING

DO NOT use the unit in wet environments, such as a laundry room, to avoid risk of electrical shock

10. **DO NOT** place any foreign objects on the unit.
11. **DO NOT** operate the unit with wet or damp hands.
12. **DO NOT** allow chemical substances to come in contact with the unit.
13. **DO NOT** operate the unit in the presence of flammable substances or vapors such as alcohols, pesticides, gasoline, etc.



WARNING

DO NOT operate the unit in explosive or flammable environments

14. **DO NOT** use the plug to start or to stop the unit. Always use the control panel to start and to stop the unit.
15. Always turn off the unit when it is not in use, and unplug the power plug from the electrical outlet.

16. Always turn the unit off and unplug the main power plug from the electrical outlet before cleaning, moving, or performing maintenance.
17. AVOID the use of adapter plugs or extension cords. If it is necessary to use an extension cord or an adapter plug to operate the unit, ensure that they are correctly rated for the application. Consult local qualified electrician and all local electrical codes to ensure proper setup. Any extension cord used with the device must be rated for a minimum of 15A.
18. DO NOT unplug the unit by pulling on the electrical cord. Keep the electrical cord away from heat sources and always completely unroll the cord to avoid overheating. If the power cord becomes damaged, a qualified service agent, qualified electrician, or similarly qualified person must replace it, in order to avoid a hazard or shock.



WARNING *DO NOT operate a unit with a damaged power cord*

19. The filters must be used with the product at all times. When the filters are removed for cleaning, always ensure that the unit has been turned off and unplugged from the electrical outlet.
20. Regularly clean the filters to maintain efficiency. If the filters are not cleaned regularly, the units output performance and efficiency will decline and energy consumption will increase.
21. DO NOT operate the unit with a damaged power cord or plug, after it malfunctions, or if the unit has been dropped or damaged.
22. Only use the unit in the upright position on a even, flat surface. Unit must be positioned at least 24 inches (60 cm) from the nearest object in any direction.
23. Stop operation immediately if abnormal noise or odor is noticed. Contact local service center.

INTRODUCTION

The information provided in this manual covers 13,200 – 60,000 BTU/HR AmeriCool by Weltem Portable Air Conditioners, their basic functions, operating procedures, options available and emergency situations. It also includes information on how to ship, store, handle, and install the equipment. Only detailed requirements of the Weltem Americool Portable Air Conditioners are described herein, and installation must be carried out in accordance with this manual. Electrical installation must also carefully follow local legislation and regulations. Only qualified personnel should conduct these installations as failure to acknowledge electrical hazards could prove to be fatal.

PRODUCT DESCRIPTION

AmeriCool by Weltem Portable Air Conditioners feature spot cooling for large areas where cooling of the entire area is not practical or possible. A dedicated spot cooling thermostat controls the unit in this application. These air conditioners can also be used in smaller areas for room cooling.

A control panel provides ease of use and contains self-diagnostic functions and displays, showing operating modes, room and set temperatures, and faults. If an abnormal operation occurs, a visual display of the fault is shown.

Caster wheels are included for ease of portability.

Suitable applications include: factory or work place, industrial kitchen, computer room, emergency cooling, outdoor event, etc.

ASSEMBLY(HPC-3000)

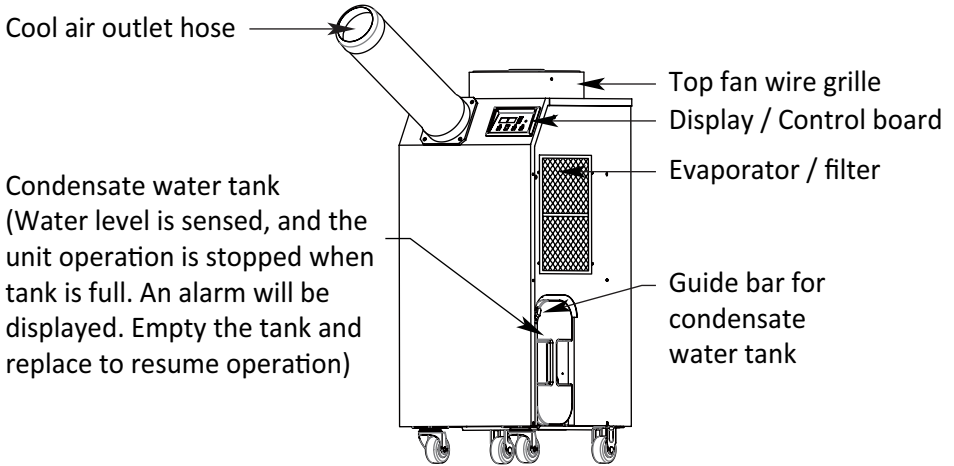

Figure 1 – Front and Right Side View

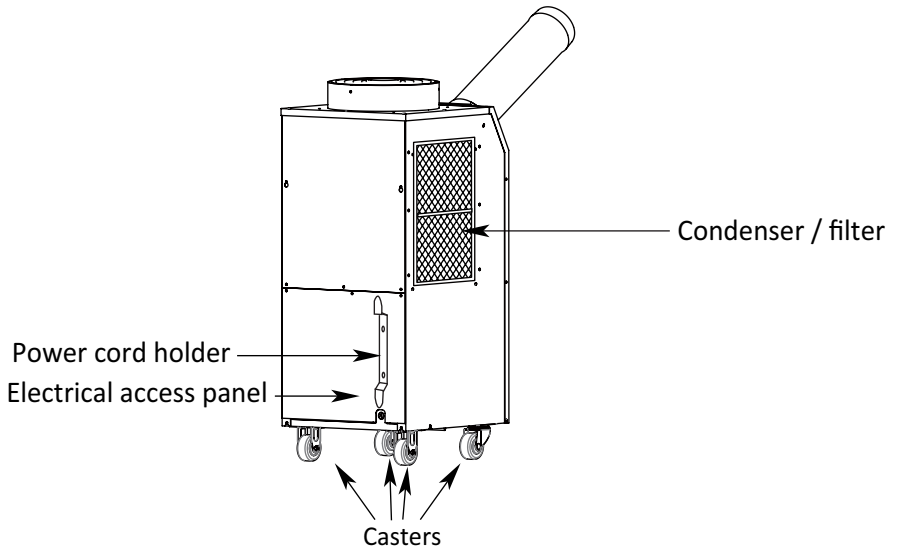

Figure 2 – Rear and Left Side View

ASSEMBLY(WPC-4000)

COMPONENT PARTS

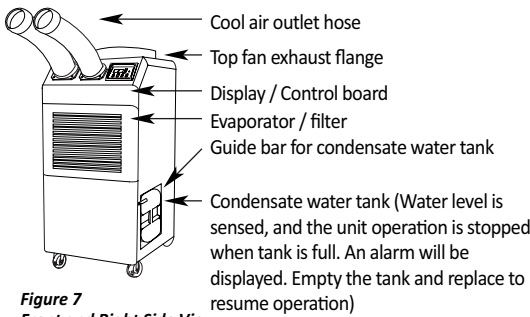

Figure 7
Front and Right Side View

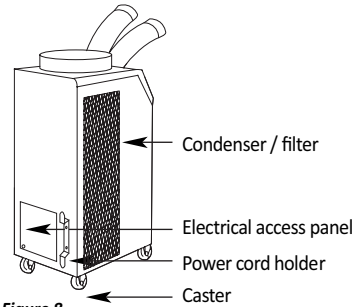

Figure 8
Back and Left Side View

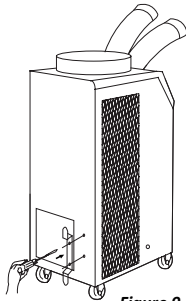

Figure 9

POWER CORD HOLDER

1. Take out the cord holder from the accessory box.
2. Place the cord holder on the back side of air conditioner.
3. Use screws (enclosed inside of accessory box with cord holder) to install the cord holder on the air conditioner as shown in Figure 9.

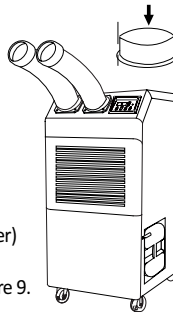

Figure 10

TOP FAN EXHAUST FLANGE

1. Remove the top fan exhaust flange from carton.
2. Place the top fan exhaust flange on the top of air conditioner.
3. Use screws (enclosed inside of box with the top fan exhaust flange) to install the top fan exhaust flange on air conditioner as shown in Figure 10.

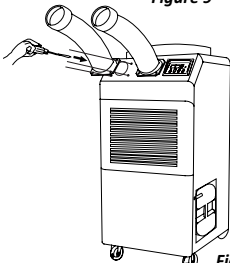

Figure 11

DISCHARGE DUCTS/SUPPLY AIR DUCT

1. Remove cool air outlet hose(s) from carton.
2. Place the cool air outlet hose(s) on the front top of air conditioner.
3. Use screws (enclosed inside of box with cool air outlet hose(s)) to install the cool air outlet hose(s) on the air conditioner as shown in Figure 11.

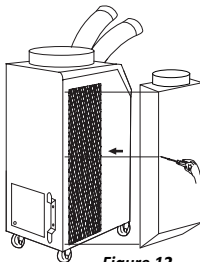

Figure 12

AMBIENT AIR ADAPTER (Optional)

An ambient air adapter can be purchased separately. Air adapter fits over the condenser to duct condenser air to the unit to improve cooling efficiency.

1. Remove air adapter from carton.
2. Place air adapter on the rear of air conditioner.
3. Use screws (enclosed inside of box with air adapter) to install the adapter on the air conditioner as shown in Figure 12.

ASSEMBLY(HPC-5000)

Component Parts

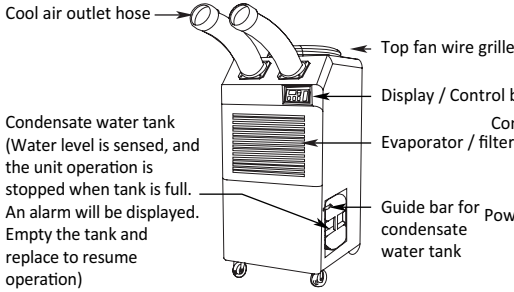

Figure 13 – Front and Right Side View

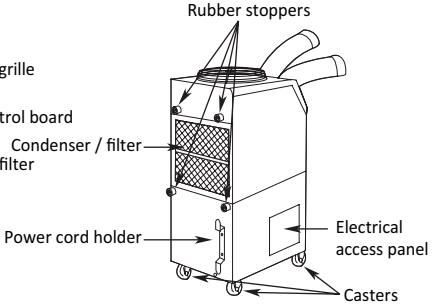

Figure 14 – Rear and Left Side View

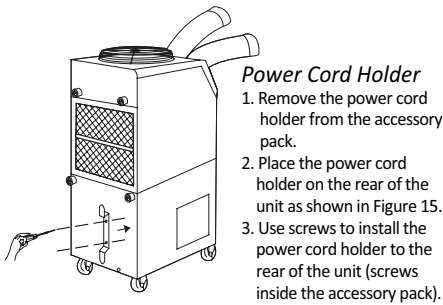

Figure 15 – Power Cord Holder attachment

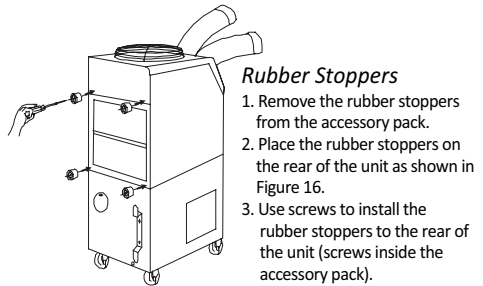

Figure 16 – Rubber Stopper attachment

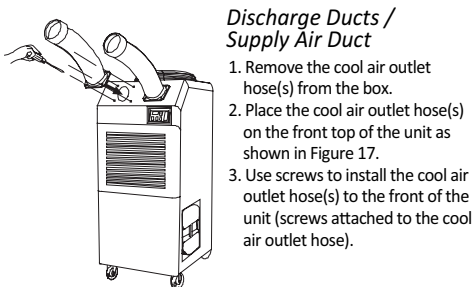

Figure 17 – Cool Air Outlet attachment

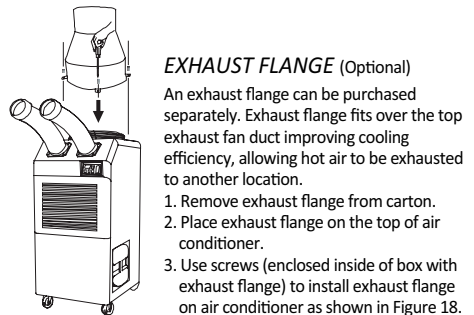

Figure 18

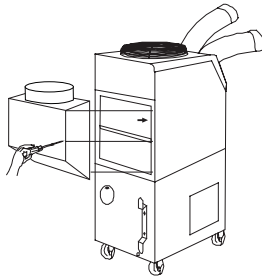

Figure 19

AMBIENT AIR ADAPTER (Optional)

An ambient air adapter can be purchased separately. Air adapter fits over the condenser to duct condenser air to the unit to improve cooling efficiency.

1. Remove air adapter from carton.
2. Place air adapter on the rear of air conditioner.
3. Use screws (enclosed inside of box with air adapter) to install the adapter on the air conditioner as shown in Figure 19.

ASSEMBLY(WPC-7000,9000)

Component Parts

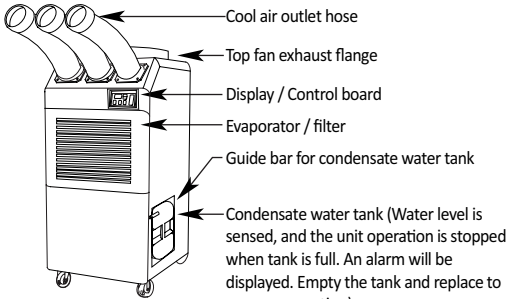

Figure 20
Front and Right Side View

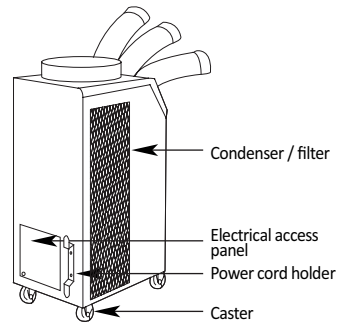

Figure 21
Back and Left Side View

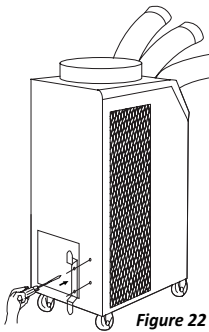

Figure 22

POWER CORD HOLDER

1. Take out the cord holder from the accessory box.
2. Place the cord holder on the back side of air conditioner.
3. Use screws (enclosed inside of accessory box with cord holder) to install the cord holder on the air conditioner as shown in Figure 22.

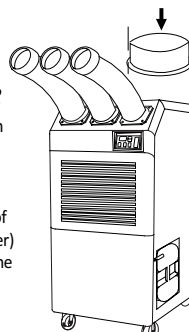

Figure 23

TOP FAN EXHAUST FLANGE

1. Remove the top fan exhaust flange from carton.
2. Place the top fan exhaust flange on the top of air conditioner.
3. Use screws (enclosed inside of box with the top fan exhaust flange) to install the top fan exhaust flange on air conditioner as shown in Figure 23.

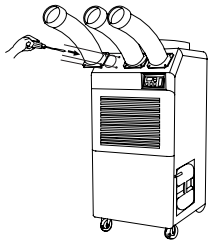

Figure 24

DISCHARGE DUCTS /SUPPLY AIR DUCT

1. Remove cool air outlet hose(s) from carton.
2. Place the cool air outlet hose(s) on the front top of air conditioner.
3. Use screws (enclosed inside of box with cool air outlet hose(s)) to install the cool air outlet hose(s) on the air conditioner as shown in Figure 24.

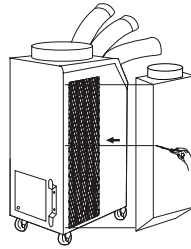

Figure 25

AMBIENT AIR ADAPTER
(Optional)

An ambient air adapter can be purchased separately. Air adapter fits over the condenser to duct condenser air to the unit to improve cooling efficiency.

1. Remove air adapter from carton.
2. Place air adapter on the side of air conditioner.
3. Use screws (enclosed inside of box with air adapter) to install the adapter on the air conditioner as shown in Figure 25.

ASSEMBLY(WPC-15000)

Component Parts

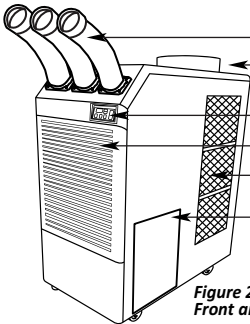

Figure 26
Front and Right Side View

Cool air outlet
Top fan exhaust flange
Display / Control board
Evaporator / filter
Condenser / filter
Drain pump included

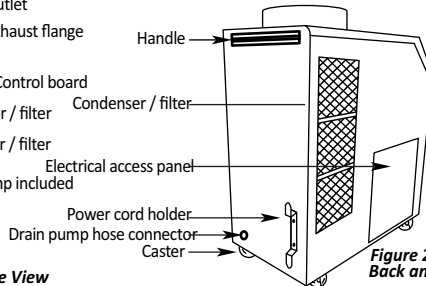

Figure 27
Back and Left Side View

Handle
Condenser / filter
Electrical access panel
Power cord holder
Drain pump hose connector
Caster

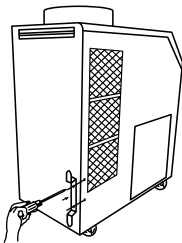

Figure 28

POWER CORD HOLDER

1. Take out the cord holder from the accessory box.
2. Place the cord holder on the back side of air conditioner.
3. Use screws (enclosed inside of accessory box with cord holder) to install the cord holder on the air conditioner as shown in Figure 28.

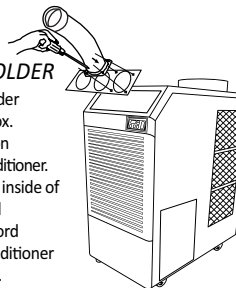

Figure 29

DISCHARGE DUCTS /SUPPLY AIR DUCT

1. Remove cool air outlet hose(s) from carton.
2. Place the cool air outlet hose(s) on the front top of air conditioner.
3. Use screws (enclosed inside of box with cool air outlet hose(s)) to install the cool air outlet hose(s) on the air conditioner as shown in Figure 29.

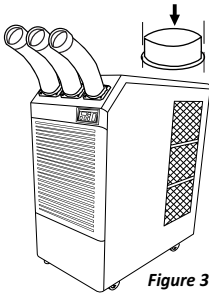

Figure 30

EXHAUST FLANGE

1. Remove the top fan exhaust flange from carton.
2. Place the top fan exhaust flange on the top of air conditioner.
3. Use screws (enclosed inside of box with the top fan exhaust flange) to install the top fan exhaust flange on air conditioner as shown in Figure 30.

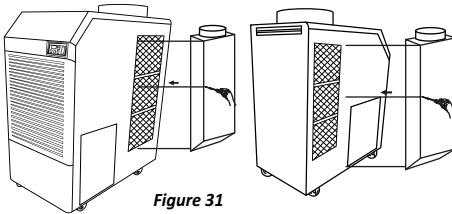

Figure 31

AMBIENT AIR ADAPTERS (Optional)

Ambient air adapters can be purchased separately. Air adapter fits over the condenser to duct condenser air to the unit to improve cooling efficiency.

1. Remove air adapters from cartons.
2. Place air adapters on the both side of air conditioner.
3. Use screws (enclosed inside of box with air adapter) to install the adapter on the air conditioner as shown in Figure 31.

INSTALLATION GUIDE

WARNINGS REGARDING PROPER LOCATION FOR INSTALLATION



WARNING

DO NOT use the unit in explosive environments or in areas where flammable gas leakage may occur



WARNING

DO NOT use the unit in areas where it will be exposed to rain or water



WARNING

DO NOT use the unit in a corrosive atmosphere



WARNING

DO NOT use the unit above 113° F (45° C)



WARNING

DO NOT install the unit on uneven or sloping surface. The unit may roll or topple over even if casters are set in the locked position

Moving the Unit

Unlock the casters and push the unit using the side handles to a flat, level surface and set the cater brakes to the locked position.

Plugging in the Unit

Check the prongs and surface of the power cord plug for dust/dirt. If dust and/or dirt are present, wipe off with a clean, dry cloth.

Check the power cord, plug, and prongs for damage or excess play.

If any damage or excess play is found, contact a qualified repair technician or a qualified electrician to perform replacement of repair of the power cord, plug, or prongs.



WARNING

If the power cord or plug are damaged, repair should only be performed by qualified electrician.



WARNING

DO NOT connect / disconnect the power cord or attempt to operate buttons with wet hands. This could result in electrical shock.

NOTE: Make sure the AC outlet is free of dirt, dust, oil, water, or any other foreign material.

The unit is equipped with an approved NEMA plug configuration (HPC-3000 = 5-15P; WPC-4000 = 5-20P; HPC-5000 = 6-15P; WPC-7000 = 6-20P; WPC-9000 = 6-30P ; WPC-15000 = 6-50P). The appropriate outlet must be used for each plug type.

OPERATION

Control Panel

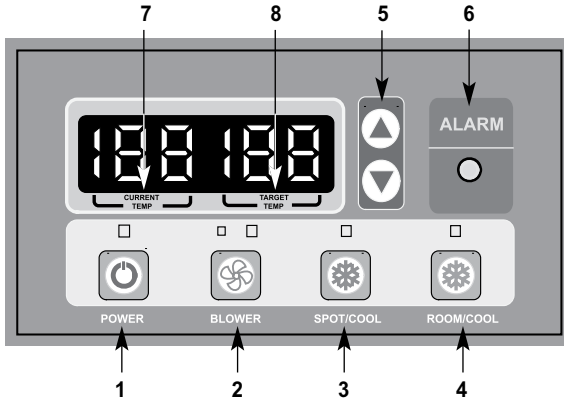

Figure 32 – Control Panel

1. POWER BUTTON

- Activates unit when POWER BUTTON is pressed.
- Fan starts on low speed.
- If POWER BUTTON is pressed during operation, unit stops.

2. BLOWER BUTTON

- Changes fan speed from LOW to HIGH when pressed.

3. SPOT / COOL BUTTON

- Activates compressor and begins producing cool air 5 seconds after button is pressed.
- Regulates temperature based on outlet cool air temperature.

4. ROOM / COOL BUTTON

- Activates compressor and produces cool air 5 seconds after button is pressed.
- Regulates temperature based on inlet ambient air temperature.

5. SET TEMP BUTTON

- Change target temperature / data value by ± 1 .
- Change data value by ± 10 by pressing continually.
- Press the SET TEMP BUTTONS to set temperature.
- Upper button is to heighten temperature and lower button is to lower temperature.

6. ALARM

- Alarm indicator light blinks and indicates abnormal system operation.
- If Alarm occurs, compressor stops.
- System operation stops when ALARM light is activated /blinking longer than 3 minutes.

7. CURRENT TEMP

- Room cool mode displays current room temperature in display in Fahrenheit
- SPOT / COOL Mode displays outlet (cool air) temperature during normal operations.
- In order to change °F to °C, press SPOT / COOL and ROOM / COOL buttons together for 2 seconds.
- C will blink 2 times and the figure will change to °C
- ALARM codes blink and are displayed when abnormal operation occurs.

8. TARGET TEMP

- Displays the unit set temperature for ROOM COOL mode only

OFF-TIMER: Enter to Timer Setting Mode if you press BLOWER Button and SPOT/COOL Button together for 1 seconds. Press UP/DOWN Button to set the timer until it shows the figure you want to set. After 5 seconds, the figure will be memorized and the compressor will stop after the time set.

AUTO RESTART: If the unit goes off due to an electrical interruption, the unit will automatically restart when the power resumes.

MAINTENANCE

Filter Cleaning

1. To clean the evaporator filter, pull the front filter guard forward from the top until the guard is open (in an angled position) and resting on the supporting cables.
2. Slide the filter up and use a vacuum cleaner to remove the dust from the filter.

Figure 33 – Removing Filters

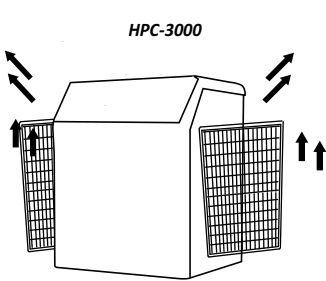

- Lift up on the side filters from the middle bar slightly and then angle the filter outwards from the bottom and remove.

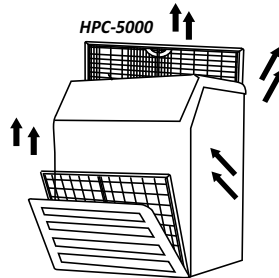

- Pull the filter frame forward to remove the front filter.
- Slide filter up and use a vacuum cleaner to remove the dust from the filter.
- Lift up on the rear filter from the middle bar slightly and then angle the filter outwards from the bottom and remove.

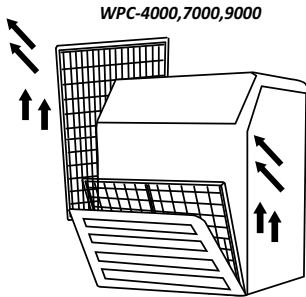

- Loosen up 2 bolts on the front filter guard.
- Slide filter up and use a vacuum cleaner to remove the dust from the filter.
- Lift up on the side filter from the middle bar slightly and then angle the filter outwards from the bottom and remove.

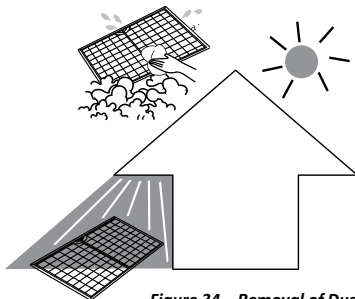
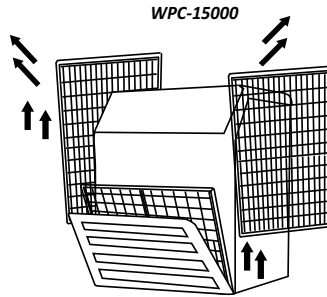

Figure 34 – Removal of Dust

- Remove dust from the filter using a vacuum cleaner hose attachment.
- If required wash the filter in lukewarm water with a mild detergent. Leave to dry in a shaded area before reinstalling.

3. If the filter is heavily covered with dust and dirt, warm water and mild soap or neutral detergent may be used to wash the filter. Do not use any other chemicals to clean the filter, as they will likely damage the filter.
4. Dry the filter in a shaded area before replacing it. Do not operate the unit without the filter installed and the filter guard in the closed position.
5. Replace the clean filter and close the filter guard.
6. To clean the condenser filter, lift up on the rear or side filter from the middle bar slightly and then angle the filter outwards from the bottom and remove.
7. Use the same cleaning procedure as in steps 3-5 above.
8. To replace the condenser filter, place the top of the filter in the guide and slide the filter up until the bottom of the filter clears the frame. Then push the bottom of the filter into the guide and let the filter gently fall inside the guide.

NOTE: For effective cooling, clean the filter at least every 2 weeks.

**WARNING**

DO NOT operate without the filter installed

**WARNING**

DO NOT operate the unit with a damaged cord or plug, after the unit malfunctions, or if the unit has been dropped or damaged.

Spring Replacement

There are two springs on the rear of the condenser water tank guide.

1. Release the screw on the spring hook.
2. Take off the spring hook, and then pull out the opposite spring hook from the hole in the condenser water tank guide.
3. Replace with a new spring in reverse order.
4. Repeat these steps for the other spring.

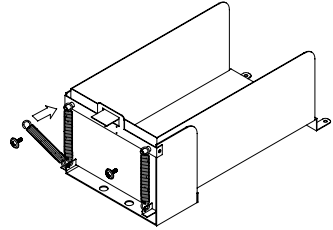









Figure 35 – Spring Replacement

TROUBLESHOOTING

The alarm light is activated if abnormal operation occurs, and a code is displayed on the control panel. The compressor and condenser fan motor will stop operating. The evaporator fan will continue to run for 3 minutes. If the fault is rectified within 3 minutes, the unit will resume operation. If the fault persists for more than 3 minutes, the evaporator fan also stops. The fault must be rectified before the unit can resume normal operation.

Alarm Codes

SELF-DIAGNOSTIC ALARM CODES			
Alarm Display	Problem	Cause	Corrective Action
	Frost prevention sensor and Abnormal temperature sensor value	<ul style="list-style-type: none"> Indoor heat exchanger temperature too low TH3 temperature sensor has a loose or broken connection 	<ul style="list-style-type: none"> Do not use the air conditioner if ambient temperature is lower than 18°C (64°F) Contact a qualified service agent
	Refrigerant high pressure switch	<ul style="list-style-type: none"> Blocked air filter Blocked /kinked exhaust duct Ambient temperature is too high 	<ul style="list-style-type: none"> Clean air filter Ensure exhaust duct is not blocked / kinked Do not use the air conditioner if ambient temperature is higher than 45°C (113°F)
	Abnormal temperature sensor value	TH1(Outlet) temperature sensor has a loose or broken connection	Contact a qualified service agent
	Abnormal temperature sensor value	TH2(Inlet) temperature sensor has a loose or broken connection	Contact a qualified service agent
	Compressor overloaded	<ul style="list-style-type: none"> Ambient temperature is too high Unstable voltage supply Defective compressor 	<ul style="list-style-type: none"> Do not use the air conditioner if ambient temperature is higher than 45°C (113°F) Contact a qualified service agent Replace compressor
	Condensate water level alarm	Condensate tank is full	<ul style="list-style-type: none"> Empty the water tank After installation of the water tank, press the SPOT/COOL or ROOM/COOL button to resume operation
	Drain pump alarm	Drain pump defective or improper hose connection (including kink or blockage)	<ul style="list-style-type: none"> Check the hose connection and hose Replace drain pump

Troubleshooting Chart

Symptom	Possible Causes	Corrective Action
Water leakage	High water level in condensate tank	<ul style="list-style-type: none"> Remove blockage from drain hose Remove any object stuck underneath of the black panel under the water tank
The unit doesn't work	<ul style="list-style-type: none"> Check the utility to verify that power is available to the unit Verify that the power cord is connected 	<ul style="list-style-type: none"> Reset the circuit breaker and restart the unit Connect the power cord
No cold air flows from the cold air outlet	<ul style="list-style-type: none"> Ambient air cannot be properly cooled if the filter is dirty and not regularly cleaned Compressor restart in 2 minutes after turning off to protect the compressor The ambient air temperature may be too high 	<ul style="list-style-type: none"> Clean air filter Verify that 2 minutes have-passed since the compressor off The temperature of the compressor can be higher when the ambient temperature is too high. The compressor will not work unless the ambient air temperature is within the acceptable operating range of the unit
Water flow can be heard after compressor shuts off	No cause	Common to hear coolant flowing after unit shuts off
Alarm displays "FT" with less than half of the condensate water in the tank	Spring is possibly broken	Replace the spring (see Maintenance section)

Specifications

Specifications	Unit	HPC-3000	WPC-4000	HPC-5000
Cooling Capacity	BTU/HR	13,200	16,800	21,000
Power Supply	PHASE	Single	Single	Single
	VOLTS	115	115	208 / 230
	HERTZ	60	60	60
Size (W x D x H)	INCHES	17.5 x 19.9 x 43.3	20.5 x 26.1 x 40.9	22.0 x 24.4 x 50.4
Weight	LBS	132	181	198
Current Consumption	AMPS	10.9	15.5	11.0 / 10.0
Circuit Breaker Size	AMPS	15	20	15
Power Consumption	KW	1.3	1.7	2.3
Compressor Input	KW	1.2	1.3	2.0
Air Flow (High/Low) Evaporator	CFM	357 / 285	470 / 400	464 / 393
Air Flow Condenser	CFM	610	1250 / 1120	857
Motor Input (High/Low) Evaporator	KW	0.091 / 0.089	0.36 / 0.26	0.24 / 0.20
Motor Input Condenser	KW	0.08		0.26
Air Filter		Aluminum	Aluminum / Vinyl chloride	Aluminum / Vinyl chloride
NEMA Plug	TYPE	5-15P	5-20P	6-15P
Power Cord Gauge	AWG	14	12	14
Power Cord Length	FT	10	6	10
Refrigerant	TYPE	R410A	R410A	R410A
	OZ	15.5	35.2	42.3
Operating Conditions	°F	64-113	64-104	64-113
Hot Air Duct Diameter	INCHES	12	12	16
Maximum Duct Length	FT	30	50	30
Safety Devices	Compressor overload protector, Anti-freezing thermister, Full drain tank switch, Automatic restart (Power interruption), Compressor time delay program, High pressure switch			
Features	Temperature control, Self-diagnostic function, Two speed fan, Optional drain pump kit, Washable filters, °F(°C)display			

Specifications	Unit	WPC-7000	WPC-9000	WPC-15000
Cooling Capacity	BTU/HR	29,000	37,000	60,000
Power Supply	PHASE	Single	Single	Single
	VOLTS	208 / 230	208 / 230	208 / 230
	HERTZ	60	60	60
Size (W x D x H)	INCHES	22.0 x 29.4 x 47.3	26.0 x 33.3 x 52.4	28.9 x 51.5 x 59.8
Weight	LBS	216	254	661
Current Consumption	AMPS	15.1 / 14.8	20.0 / 19.0	32.0/30.0
Circuit Breaker Size	AMPS	20	30	50
Power Consumption	KW	3.3	4.4	7
Compressor Input	KW	2.4	3.5	4.8
Air Flow (High/Low) Evaporator	CFM	741 / 635	882 / 776	2000 / 1870
Air Flow Condenser	CFM	1560	1660	3600
Motor Input (High/Low) Evaporator	KW	0.9/0.8	0.6/0.5	0.4/0.35
Motor Input Condenser	KW			1
Air Filter		Aluminium / Vinyl chloride	Aluminium / Vinyl chloride	Aluminium / Vinyl chloride
NEMA Plug	TYPE	6-20P	6-30P	6-50P
Power Cord Gauge	AWG	12AWG	10AWG	8AWG
Power Cord Length	FT	10	10	6
Refrigerant	TYPE	R-410a	R-410a	R-410a
	OZ	44.4	61	91
Operating Conditions	°F	64~113	64~113	64~113
Hot Air Duct Diameter	INCHES	16	16	20
Maximum Duct Length	FT	60	60	100
Safety Devices	Compressor overload protector, Anti-freezing thermister, Full drain tank switch, Automatic restart (Power interruption), Compressor time delay program, High pressure switch			
Features	Temperature control, Self-diagnostic function, Two speed fan, Optional drain pump kit, Washable filters, °F(°C)display			

Wiring Diagram

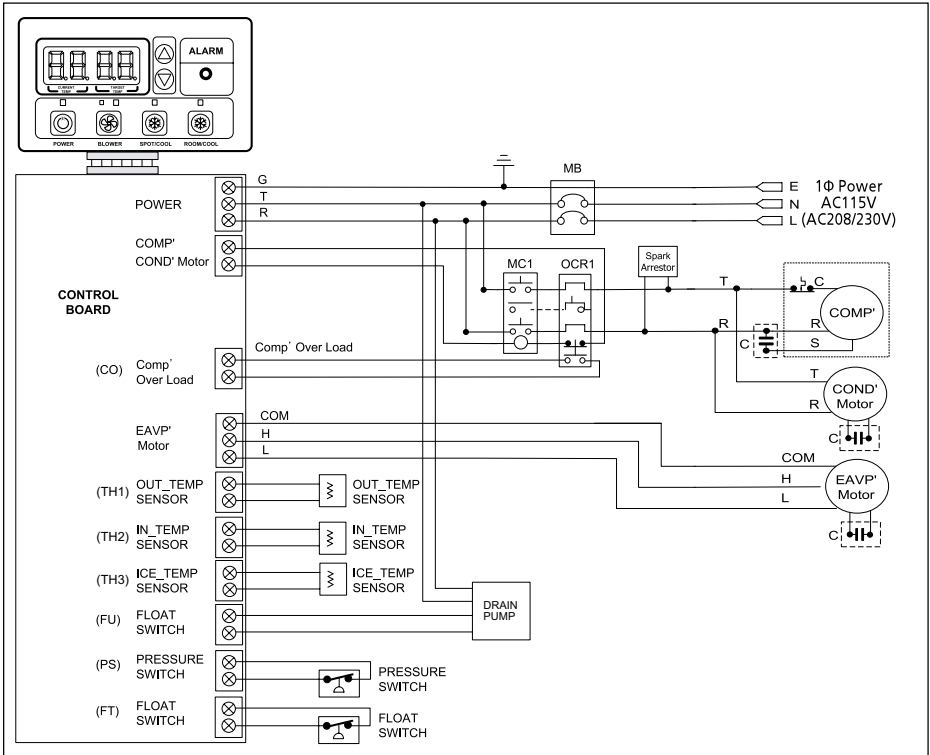

Figure 36 - Circuit Wiring Diagram (Models HPC-3000 / HPC-5000 / HPC-7000)

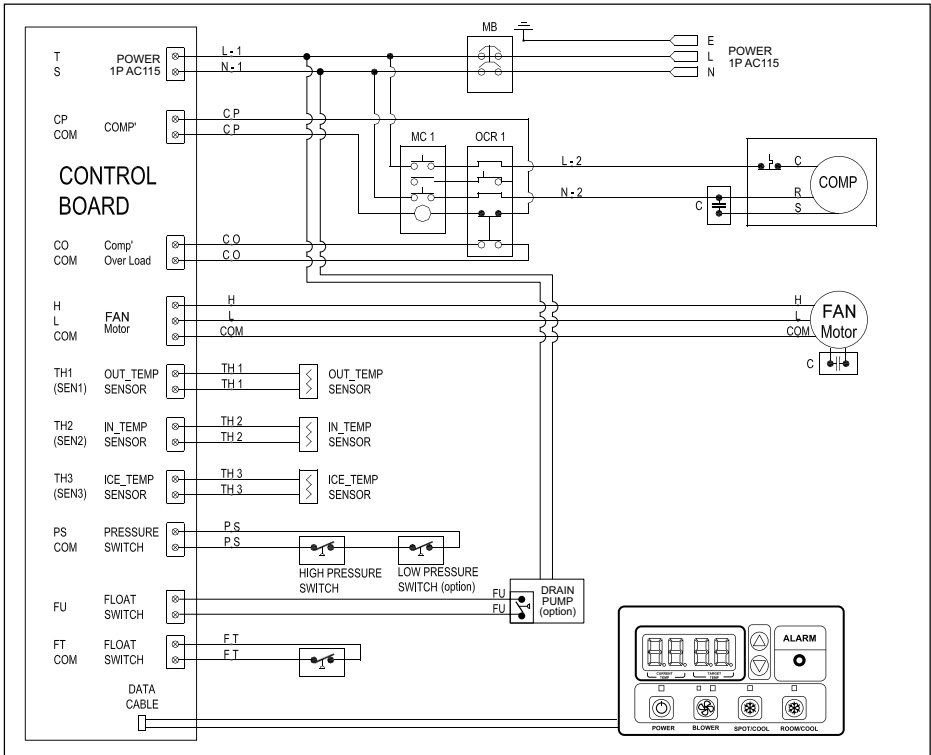

Figure 37 - Circuit Wiring Diagram (Models WPC-4000)

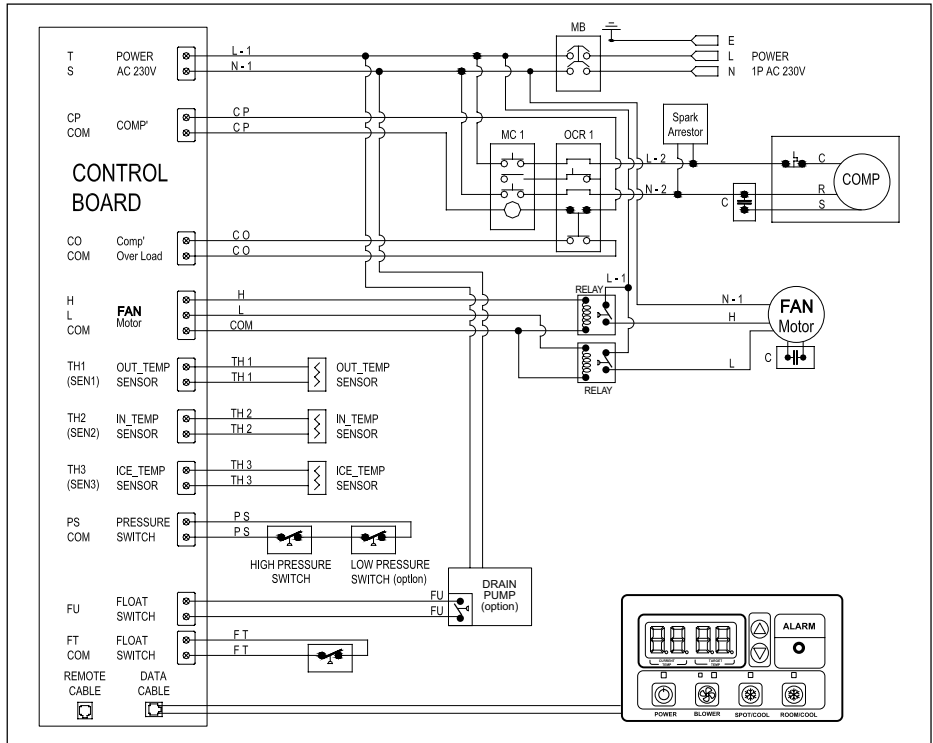

Figure 38 - Circuit Wiring Diagram (Models WPC-7000 / WPC-9000)

Wiring Diagram

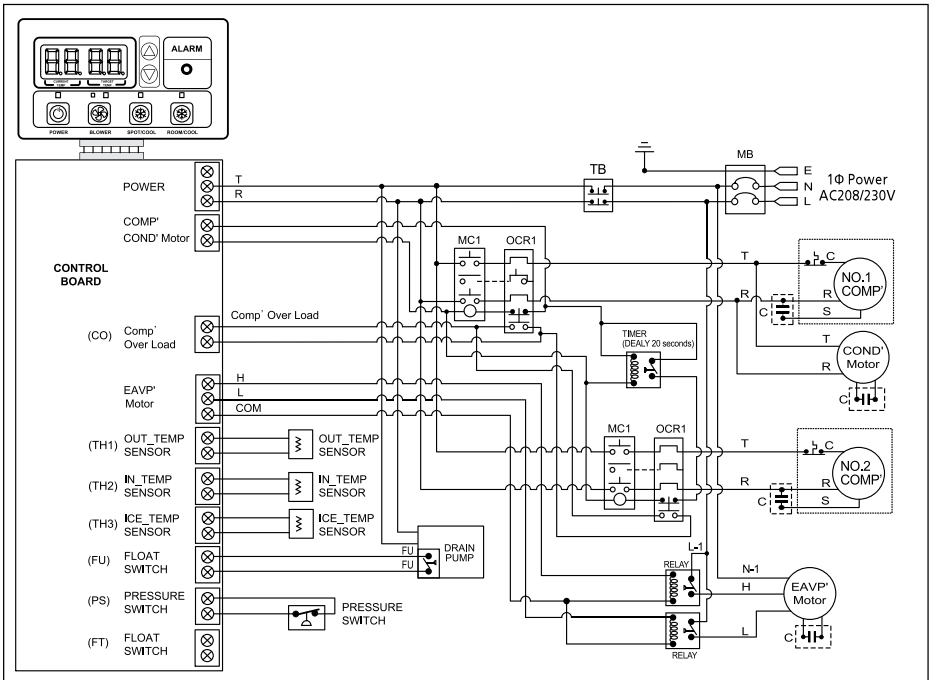

Figure 39 - Circuit Wiring Diagram (Models WPC-15000)

SHIPPING LIST

- (1) PORTABLE AIR CONDIRIONER
- (1) Owner's Manual
- (1) POWER CORD HOLDER
- (4) RUBBER STOPPERS (for HPC-5000)
- DISCHARGE / SUPPLY AIR DUCTS
 - (1) HPC-3000
 - (2) WPC-4000
 - (2) HPC-5000
 - (3) WPC-7000
 - (3) WPC-9000
 - (3) WPC-15000
- (1) EXHAUST FLANGE (for WPC-4000,7000,9000,15000)

OBTAINING SERVICE

If the AmeriCool by Weltem Portable Air Conditioner requires Service:

1. Use the TROUBLESHOOTING section in this manual to eliminate obvious causes.
2. Verify there are no circuit breakers tripped.
3. Call your dealer for assistance. If you cannot reach your dealer, or if they cannot resolve the problem, call AmeriCool by Weltem Portable Air Conditioner Technical Support at 562.231.7175. Please have the following information available BEFORE calling the Technical Support Department:
 - a. Your name and address.
 - b. The serial number of the unit.
 - c. Where and when the unit was purchased.
 - d. All of the model information about your AmeriCool by Weltem Portable Air Conditioner.
 - e. Any information on the failure, including LED's that may or may not be illuminated.
 - f. A description of the protected equipment, including model numbers if possible.

LIMITED WARRANTY

AMERICOOOL ONE-YEAR LIMITED WARRANTY. AMERICOOOL BY WELTEM PORTABLE AIR CONDITIONERS, MODELS COVERED IN THIS MANUAL, ARE WARRANTED BY AMERICOOOL TO THE ORIGINAL USER AGAINST DEFECTS IN WORKMANSHIP OR MATERIALS UNDER NORMAL USE FOR ONE YEAR AFTER DATE OF PURCHASE. ANY PART WHICH IS DETERMINED TO BE DEFECTIVE IN MATERIAL OR WORKMANSHIP AND RETURNED TO AN AUTHORIZED SERVICE LOCATION, AMERICOOOL DESIGNATES, SHIPPING COSTS PREPAID, WILL BE, AS THE EXCLUSIVE REMEDY, REPAIRED OR REPLACED BY AMERICOOOL OPTION. FOR LIMITED WARRANTY CLAIM PROCEDURES, SEE "PROMPT DISPOSITION" BELOW. THIS LIMITED WARRANTY GIVE PURCHASERS SPECIFIC LEGAL RIGHTS WHICH VARY FROM JURISDICTION TO JURISDICTION.

LIMITATION OF LIABILITY. TO THE EXTENT ALLOWABLE UNDER APPLICABLE LAW, AMERICOOOL LIABILITY FOR CONSEQUENTIAL AND INCIDENTAL DAMAGES IS EXPRESSLY DISCLAIMED. AMERICOOOL LIABILITY IN ALL EVENTS IS LIMITED TO AND SHALL NOT EXCEED THE PURCHASE PRICE PAID.

WARRANTY DISCLAIMER. A DILIGENT EFFORT HAS BEEN MADE TO PROVIDE PRODUCT INFORMATION AND ILLUSTRATE THE PRODUCTS IN THIS LITERATURE ACCURATELY; HOWEVER, SUCH INFORMATION AND ILLUSTRATIONS ARE FOR THE SOLE PURPOSE OF IDENTIFICATION, AND DO NOT EXPRESS OR IMPLY A WARRANTY THAT THE PRODUCTS ARE MERCHANTABLE, OR FIT FOR PARTICULAR PURPOSE, OR THAT THE PRODUCTS WILL NECESSARILY CONFORM TO THE ILLUSTRATIONS OR DESCRIPTIONS. EXCEPT AS PROVIDED BELOW, NO WARRANTY OF AFFIRMATION OF FACT, EXPRESSED OR IMPLIED, OTHER THAN AS STATED IN THE "LIMITED WARRANTY" ABOVE IS MADE OR AUTHORIZED BY AMERICOOOL.

Technical Advice and Recommendations, Disclaimer. Notwithstanding any past practice or dealings or trade custom, sales shall not include the furnishing of technical advice or assistance or system design. Americool assumes no obligations or liability on account of any unauthorized recommendations, opinions or advice as to the choice, installation or use of products.

Product Suitability. Many jurisdictions have codes and regulations governing sales, construction, installation, and/or use of products for certain purposes, which may vary from those in neighboring areas. While attempts are made to assure that Americool products comply with such codes, Americool cannot guarantee compliance, and cannot be re-

sponsible for how the product is installed or used. Before purchase and use of a product, review the product applications, and all applicable national and local codes and regulations, and be sure that the product, installation, and use will comply with them.

Certain aspects of disclaimers are not applicable to consumer products; e.g., (a) some jurisdictions do not allow the exclusion or limitation of incidental or consequential damages, so the above limitation or exclusion may not apply to you; (b) also, some jurisdictions do not allow a limitation on how long an implied warranty lasts, consequently the above limitation may not apply to you; and (c) by law, during the period of this Limited Warranty, any implied warranties of implied merchantability or fitness for a particular purpose applicable to consumer products purchased by consumers, may not be excluded or otherwise disclaimed.

Prompt Disposition. A good faith effort will be made for prompt correction or other adjustment with the respect to any product which proves to be defective within limited warranty. For any product believed to be defective within limited warranty, first write or call dealer from whom the product was purchased. Dealer will give additional directions. If unable to resolve satisfactorily, write to Americool at the address below, giving dealer's name, address, date, and number of dealer's invoice, and describing the nature of the defect. Title and risk of loss pass to buyer on delivery to common carrier. If product was damaged in transit to you, file claim with carrier.

Manufactured in Weltem Co., Ltd.,
973-5, Yangdeok-dong, Masanhoewon-gu, Changwon-City, Gyeongnam,
Republic of KOREA 630-728 www.weltem.com

Distributed by Americool, Inc. In the USA (Tel.562-231-7175)

printed in May, 2012